

TROUBLESHOOTING

For more troubleshooting and tips, visit www.TheWorldIsNowGame.com or reference troubleshooting in Recoil Mobile App.

PROBLEM	SOLUTION
Is the Recoil mobile app required to use the Recoil Starter set?	Yes, a supported iOS or Android device and the free downloadable Recoil mobile app are required for all Recoil gameplay.
Unable to connect to the Wi-Fi Game Hub	<ul style="list-style-type: none"> • Ensure that fresh batteries have been installed and the power button LED is illuminated solid green. • Confirm whether you have connected to a different network in your devices Wi-Fi Settings and try to reconnect to the "Recoil Game Hub_XXXXXXX" network • Reboot the Game Hub and try to reconnect to the network from your device Wi-Fi settings.
RK-45 SPITFIRE is not connecting to the app	<ul style="list-style-type: none"> • Confirm that Bluetooth is enabled in your devices settings • Restart the app and turn on the RK-45 SPITFIRE once you have reached the main menu.
I am getting disconnected from the Wi-Fi Game Hub during gameplay	<ul style="list-style-type: none"> • Ensure that the Game Hub is placed 3-5 feet (90 - 150cm) off the ground during gameplay • Ensure that the Game Hub antenna is fully extended and unobstructed • Ensure that you are standing within 250 feet (76m) of the Wi-Fi Game Hub • Ensure that the Game Hub has fresh batteries installed
GPS functionality is not accurate	<ul style="list-style-type: none"> • GPS features will only work outdoors. See app for details on indoor gameplay modes. • Ensure that you are in a location capable of acquiring a strong GPS signal. • Optimal play spaces include open areas, away from tall buildings and structures. • Confirm that you have location services turned on for the Recoil mobile app in your device settings.

BATTERY SPECIFICATIONS & CAUTIONS

REQUIRES 12x **AA (LR06) 1.5V**
Not Included

- Do not use rechargeable batteries.
- Non-rechargeable batteries are not to be recharged.
- Different types of batteries or new and old batteries are not to be mixed.
- Batteries are to be inserted using correct polarity.
- Remove exhausted batteries as soon as possible and discard properly.
- Remove all batteries from compartment if toy is not used for more than seven months.

• The supply terminals are not to be short circuited.
Not suitable for children under 3 years due to small parts. Remove and discard wire ties before giving this product to children.
Keep this information for future reference.
PRODUCT COLORS AND STYLES MAY VARY FROM THOSE SHOWN.

Google Play is a trademark of Google Inc. - Apple, the Apple logo, the iPhone and the App Store are trademarks of Apple Inc., registered in the U.S. and other countries. The App Store is a service mark of Apple inc.

WARNINGS: The product may be mistaken for an actual firearm by police officers and others and that altering in state or federal markings or coloration in order to make the product more realistic is dangerous and may be a crime and that brandishing or displaying the product in public may cause confusion and may be a crime. Criminal penalties under state law that may arise from use of the replica firearm and describe the prohibited activity.

SAFETY WARNINGS:

- Always maintain awareness of your surroundings
- Keep a safe distance away from streets, public thoroughfares and power lines, near high voltage poles, railway tracks, road, or swimming pools
- Avoid noise canceling headphones and adjust volume to a level that allows you to hear surrounding noise
- Ensure that your device is securely tightened in the attached phone mount
- Contains a long cord and straps which are strangulation hazard for young children. Keep out of reach of children under 3
- Do not aim at eyes or face

CAUTION: Consumers should confirm the lawful use of this product with local authorities as laws may vary.

Smartphone required. Not included.
Works with most iPhones and Android devices.
Headphones recommended but not included.

This device is marked with the selective sorting symbol on waste electrical and electronic equipment. This means that this product should be supported by a selective collection system in accordance with applicable regulations in order to be either recycled or dismantled in order to reduce any impact on the environment. The batteries, submitted to a specific collection system, must be removed from the product and disposed of separately. When this product has reached the end of its useful life it should not be disposed of with other household waste. The Waste Electrical and Electronic Equipment Regulations require it to be separately collected so that it can be treated using the best available recovery and recycling techniques. Electrical and electronic products as well as batteries that have not been sorted before disposal are potentially dangerous for the environment and human health due to the presence of hazardous substances. For more information, contact your local or regional government.



RECOIL

GPS LASER COMBAT

AGES 12+

MULTI-PLAYER STARTER SET

CONTENTS:

- 2 - RK-45 SPITFIRE Recoil Weapons
- 1 - Wi-Fi Game Hub
- 2 - Phone Mounts
- 1 - Quick Start Guide

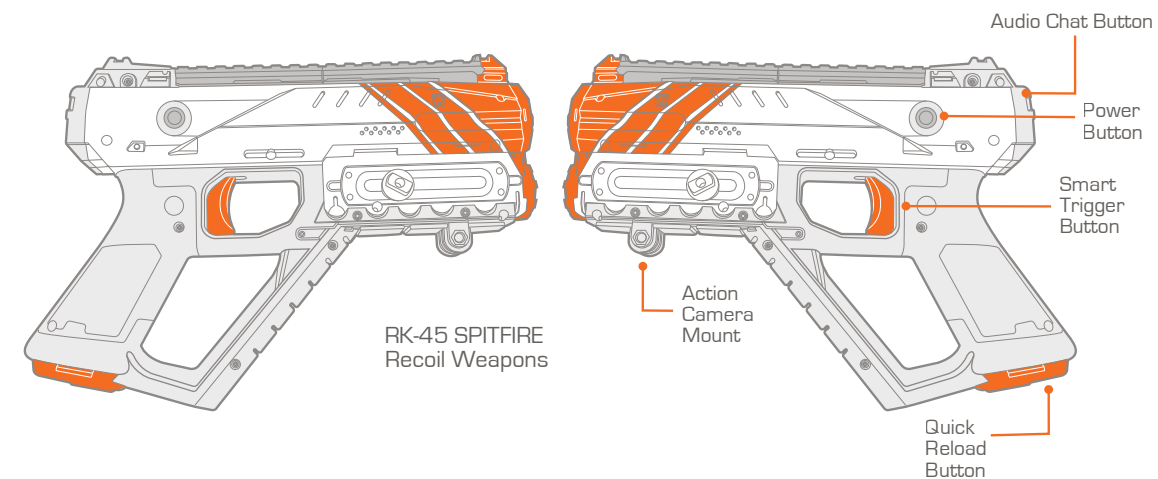
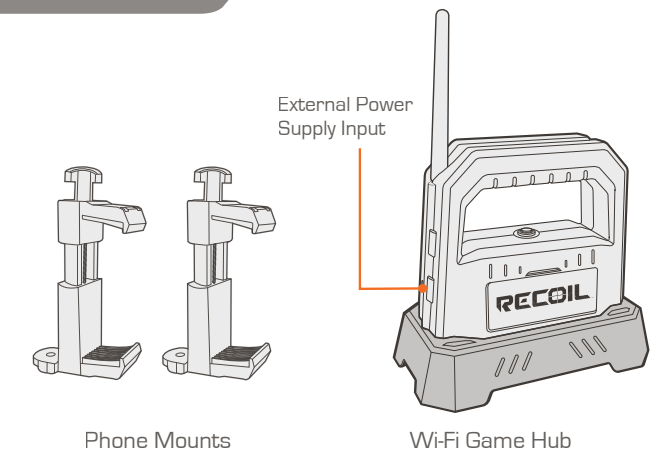

WHAT YOU NEED (Not Included):

- Requires 12X AA Batteries
- Compatible iOS or Android Mobile Devices
- Free Downloadable RECOIL Mobile App
- Safe play area with a minimum of 2 players
- Headphones (RECOMMENDED)
- Screwdriver

AA (LR06) 1.5V
Not Included

ALSO AVAILABLE:

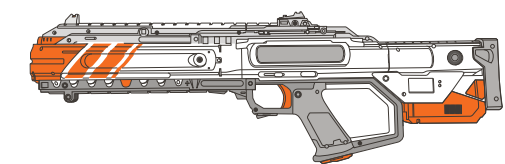

SR-12 ROGUE
ADD-ON TAG WEAPON
(Sold Separately)

SKYROCKET

Questions or comments?
Please call 888-674-5650 or
visit www.TheWorldIsNowGame.com

©2018 Skyrocket LLC, Los Angeles, CA 90066 USA. All Rights Reserved. Recoil and the Skyrocket logo are trademarks of Skyrocket LLC. Other trademarks and trade names are those of their respective owners, and there is no relationship express or implied with Skyrocket LLC.
MADE IN CHINA.



01933-IM-G2

The Bluetooth word mark and logos are registered trademarks owned by Bluetooth SIG, Inc., and any use of such marks by Skyrocket is under license. Other trademarks and trade names are those of their respective owners.

Wi-Fi GAME HUB: Battery Installation

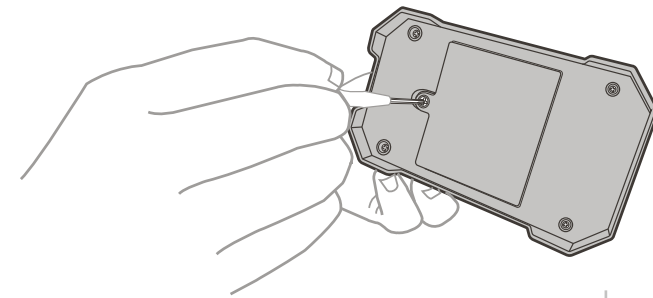

- 1 Remove Wi-Fi Game Hub battery compartment door.

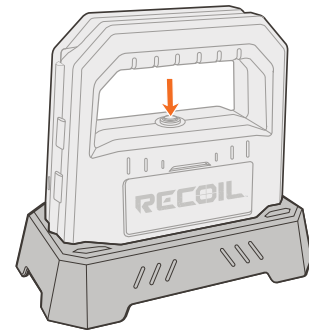

- 3 Push power button to turn on Wi-Fi Base Station. Wait for GREEN LED power light to be solid before attempting to connect to the Wi-Fi network from your mobile device.

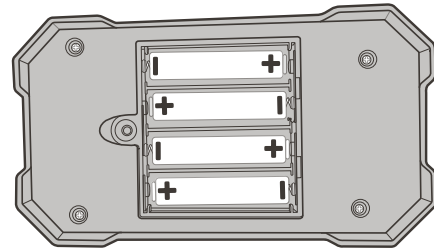

AA (LR06) 1.5V
Not Included

- 2 Insert 4 AA batteries. Put battery compartment door back on.

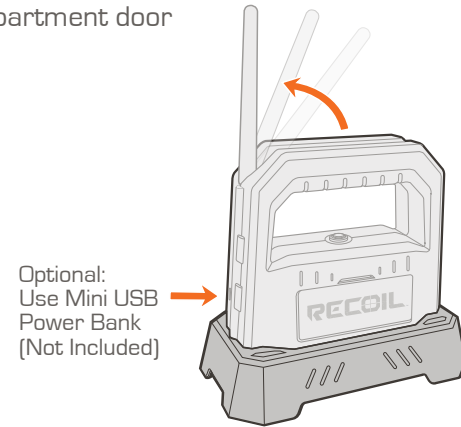

- 4 Extend antenna. Wi-Fi Game Hub should be placed on a **3-5 foot elevated** surface for best performance. Turn off Wi-Fi Game Hub when not in use.

RK-45 SPITFIRE: Battery Installation

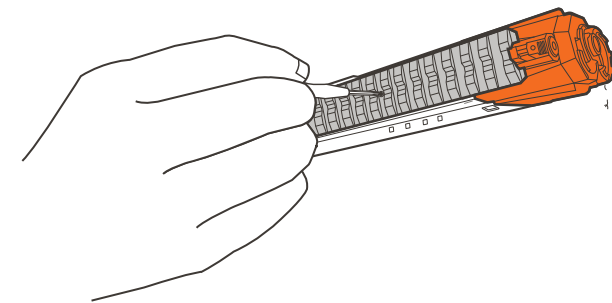

- 1 Remove RK-45 SPITFIRE's battery compartment door.

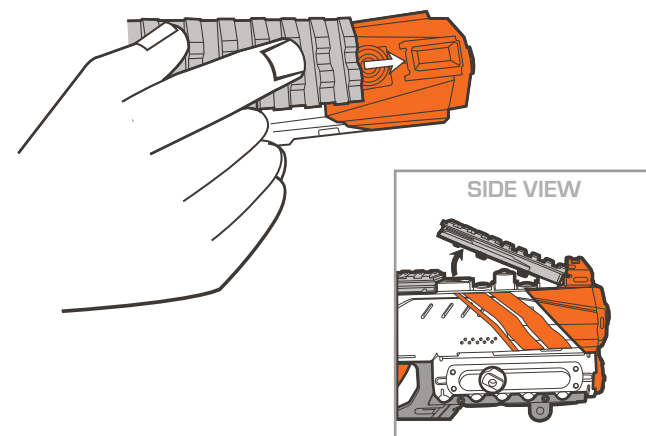

- 3 Put battery compartment door back on.

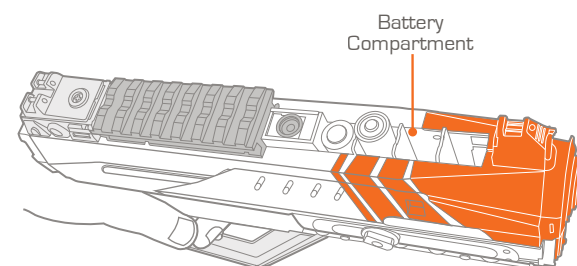

- 2 Insert 4 AA batteries.



- 4 Hold power button for 1 seconds to turn On or OFF.

ATTACH PHONE MOUNT

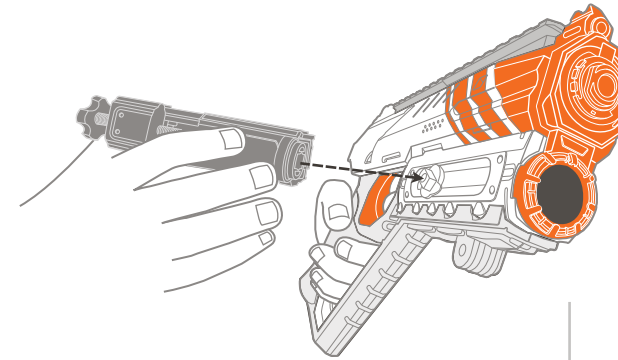

- 1 Align phone mount on right or left side of RK-45 SPITFIRE.

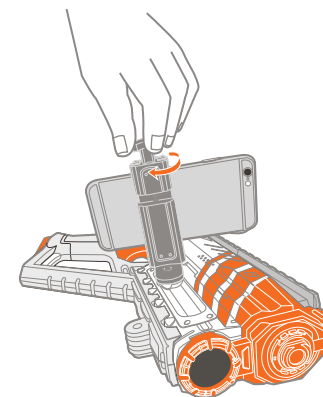

- 3 Loosen clamp and insert mobile device. Then tighten clamp to secure.

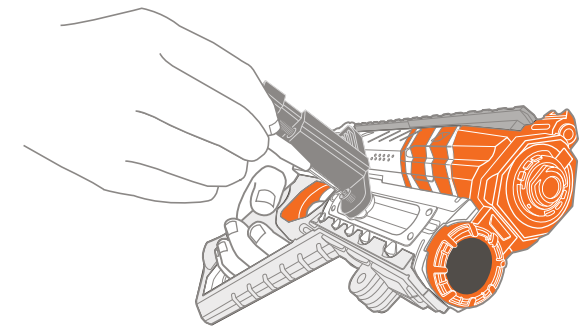

- 2 Insert provided screw and tighten to secure.

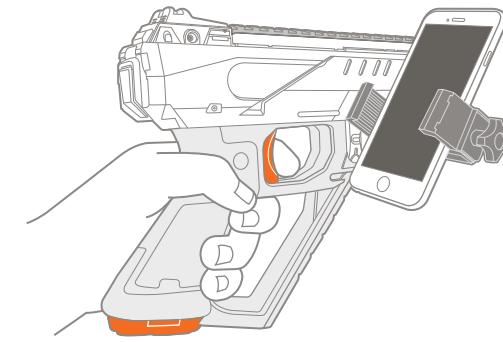

- 4 Make sure mount and mobile device are tightly secured. NOTE: Use a protective case (not included) for your mobile device while secured in the phone mount.

DOWNLOAD RECOIL APP:

Download the FREE
Recoil Mobile App



Launch App and follow instructions for connecting Recoil hardware.

Confirm your Wi-Fi & Bluetooth settings are turned on in your mobile device.